

xfree s

**5 YEARS
WARRANTY**

CASAMBI
by TRIDONIC



EN

System of light fittings for surface or suspended mounting, for continuous luminous lines, equipped with LEDs linear or curved modules at 48V DC.

The light fittings from this range can be mounted also as individual luminaires using the appropriate accessories.

All the mounting and connecting accessories have to be ordered separately.

Extruded aluminum profile, electrostatically painted with sandblasted finishing.

Satin opal diffuser in PMMA.

Two blocks of terminals, WAGO type 2P, one at each side, to assemble the continuous structures.

Range of applications

General or local lighting in offices, reception areas, conference rooms or public working spaces.

RO

Sistem de corpuri de iluminat pentru montaj aparent sau suspendat, echipate cu module liniare sau curbe cu LED-uri alimentate la 48V DC, cu posibilitatea de realizare a structurilor luminoase continue.

Corpurile de iluminat pot fi montate și individual utilizând accesoriile corespunzătoare.

Toate accesoriile de montaj și de conexiune se comandă separat.

Profil din aluminiu extrudat, vopsit în câmp electrostatic, cu finisaj sablat.

Dispensar opal satinat din PMMA.

Două cleme de conexiuni tip WAGO, câte una la fiecare capăt, conectate între ele pentru realizarea de structuri continue.

Aplicații

Iluminatul general sau local în birouri, zone de recepție, săli de conferințe sau spații de lucru cu publicul.



IT

Sistema di apparecchi per montaggio di superficie o a sospensione, dotati di moduli lineari o curvi a LED alimentati a 48V DC, permette la realizzazione di strutture luminose lineari o curve.

Gli apparecchi di questo sistema, possono anche essere montati singolarmente utilizzando gli accessori appropriati.

Tutti gli accessori di montaggio e di connessione devono essere ordinati separatamente.

Profilo estruso di alluminio, verniciato a polveri, finitura sabbata. Diffusore in PMMA satinato opalino.

Due morsetti tipo WAGO, uno a ciascuna estremità, collegati tra loro in modo da ottenere una struttura continua.

Campi di applicazione

Illuminazione generale o locale di uffici, zone di ricezione, sale conferenza o spazi pubblici.

IMPORTANT

The intensity of the light for the luminaires in an XFREE S SURFACE/SUSPENDED system can be adjusted using the CASAMBI protocol, by means of the DALI controller with integrated source basicDIM Wireless G2 and the OSRAM Oti DALI DIM 1-4CH D 48V dimmer, installed between the driver at constant voltage 48V output and the load..

IMPORTANT

Intensitatea luminoasă a corpurile de iluminat dintr-un sistem XFREE S SURFACE/SUSPENDED poate fi reglată folosind protocolul CASAMBI, prin intermediul regulatorului DALI cu sursă integrată basicDIM Wireless G2 și a dimer-ului OSRAM Oti DALI DIM 1-4CH D 48V, instalat între alimentatorul la tensiune constantă de 48V și sarcină.

IMPORTANTE

L'intensità della luce per gli apparecchi di un sistema XFREE S SUPERFICIE/SUSPENDED può essere regolata tramite protocollo CASAMBI, utilizzando il controller DALI con sorgente integrata basicDIM Wireless G2 e il dimmer OSRAM Oti DALI DIM 1-4CH D 48V, installato tra l'alimentatore a tensione costante 48V ed il carico.

xfree s

LINEAR PROFILES

FINISHING AVAILABLE

SWH SBK

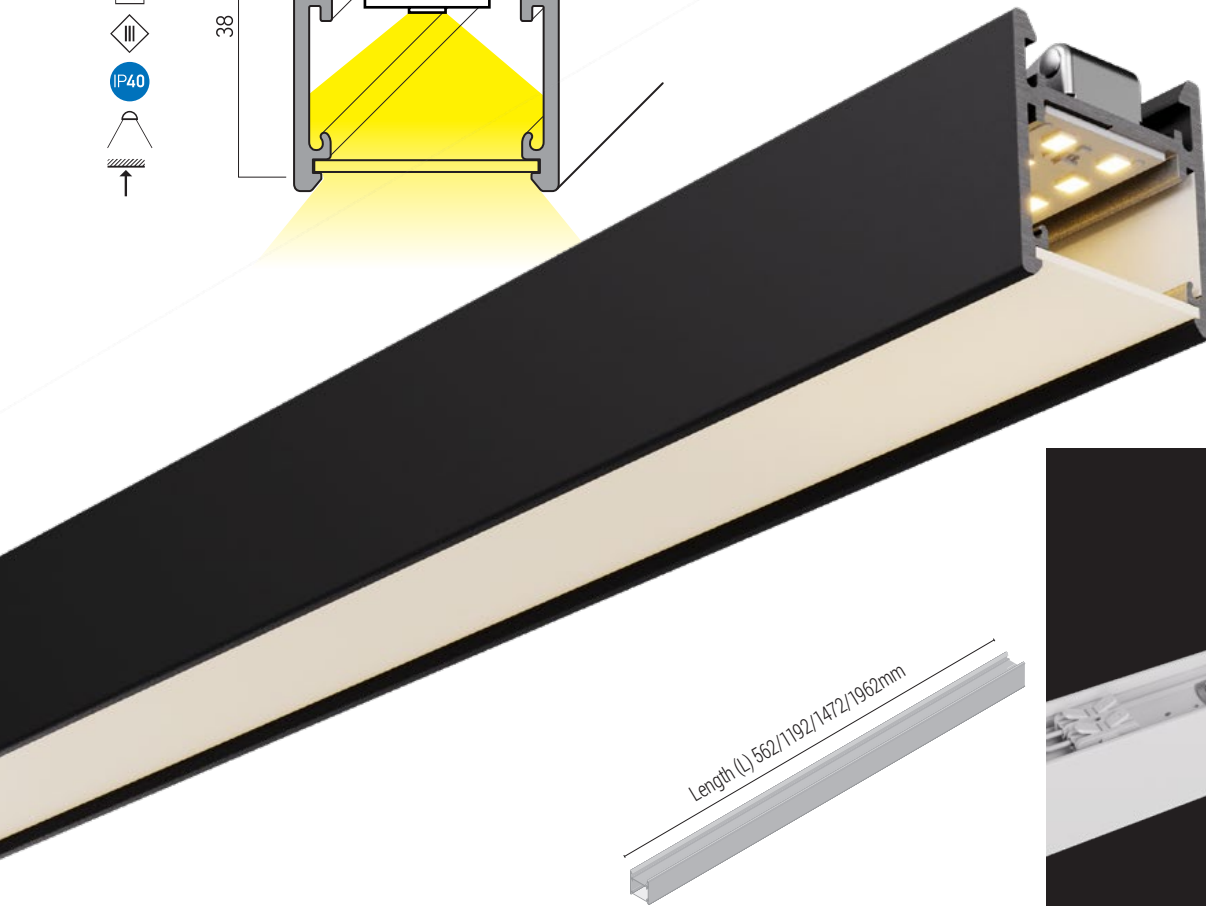
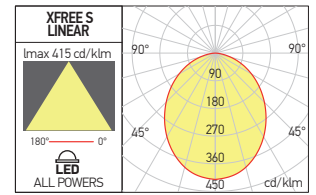
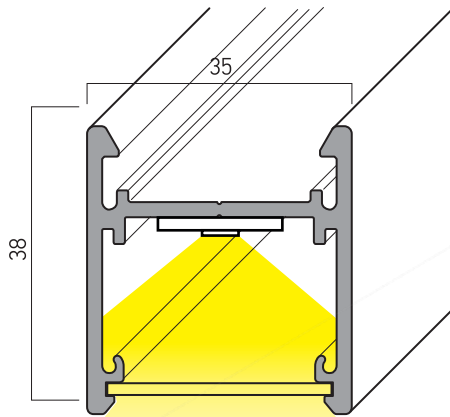
CASAMBI
by TRIBONIC

Length (L) 562/1192/1472/1962mm



Code	Finishing	LED type	Power	Input voltage	Driver	LED flux	System flux	CCT	CRI	Optics	Length (L)	Weight
FES35WW15 SWH	SWH	LEDs MODULE	14W	48V DC	Excluded	1600 lm	1049 lm	3000K	90	100°	562 mm	0,55 kg
FES35WW15 SBK	SBK	LEDs MODULE	14W	48V DC	Excluded	1600 lm	1049 lm	3000K	90	100°	562 mm	0,55 kg
FES35NW15 SWH	SWH	LEDs MODULE	14W	48V DC	Excluded	1642 lm	1091 lm	4000K	90	100°	562 mm	0,55 kg
FES35NW15 SBK	SBK	LEDs MODULE	14W	48V DC	Excluded	1642 lm	1091 lm	4000K	90	100°	562 mm	0,55 kg
FES35WW30 SWH	SWH	LEDs MODULE	28W	48V DC	Excluded	3200 lm	2101 lm	3000K	90	100°	1192 mm	1,10 kg
FES35WW30 SBK	SBK	LEDs MODULE	28W	48V DC	Excluded	3200 lm	2101 lm	3000K	90	100°	1192 mm	1,10 kg
FES35NW30 SWH	SWH	LEDs MODULE	28W	48V DC	Excluded	3284 lm	2186 lm	4000K	90	100°	1192 mm	1,10 kg
FES35NW30 SBK	SBK	LEDs MODULE	28W	48V DC	Excluded	3284 lm	2186 lm	4000K	90	100°	1192 mm	1,10 kg
FES35WW37 SWH	SWH	LEDs MODULE	36W	48V DC	Excluded	4120 lm	2711 lm	3000K	90	100°	1472 mm	1,40 kg
FES35WW37 SBK	SBK	LEDs MODULE	36W	48V DC	Excluded	4120 lm	2711 lm	3000K	90	100°	1472 mm	1,40 kg
FES35NW37 SWH	SWH	LEDs MODULE	36W	48V DC	Excluded	4224 lm	2821 lm	4000K	90	100°	1472 mm	1,40 kg
FES35NW37 SBK	SBK	LEDs MODULE	36W	48V DC	Excluded	4224 lm	2821 lm	4000K	90	100°	1472 mm	1,40 kg
FES35WW50 SWH	SWH	LEDs MODULE	50W	48V DC	Excluded	5600 lm	3756 lm	3000K	90	100°	1962 mm	1,85 kg
FES35WW50 SBK	SBK	LEDs MODULE	50W	48V DC	Excluded	5600 lm	3756 lm	3000K	90	100°	1962 mm	1,85 kg
FES35NW50 SWH	SWH	LEDs MODULE	50W	48V DC	Excluded	5880 lm	3908 lm	4000K	90	100°	1962 mm	1,85 kg
FES35NW50 SBK	SBK	LEDs MODULE	50W	48V DC	Excluded	5880 lm	3908 lm	4000K	90	100°	1962 mm	1,85 kg

Linear light fittings with surface or suspended mounting, for continuous luminous lines, with connection at 90°, in T or cross mounting, or for individual installing, equipped with LEDs modules, powered at 48V DC.

Corpur de iluminat liniare pentru montaj aparent sau suspendat, cu posibilitatea de realizare a structurilor liniare continue, cu unghiuri la 90°, în T sau în cruce, sau cu instalare individuală, echipate cu module cu LED-uri la 48V DC.

Apparecchi lineari per montaggio di superficie o da sospensione, dotati di moduli lineari a LED SMD a 48V DC, permettendo la realizzazione di strutture luminose lineari, con angoli a 90°, connessioni a T o a croce, o montaggio singolarmente.

CURVED PROFILES

FINISHING AVAILABLE

SWH SBK

CASAMBI
by TRIDONIC

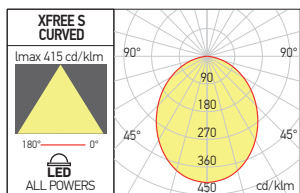
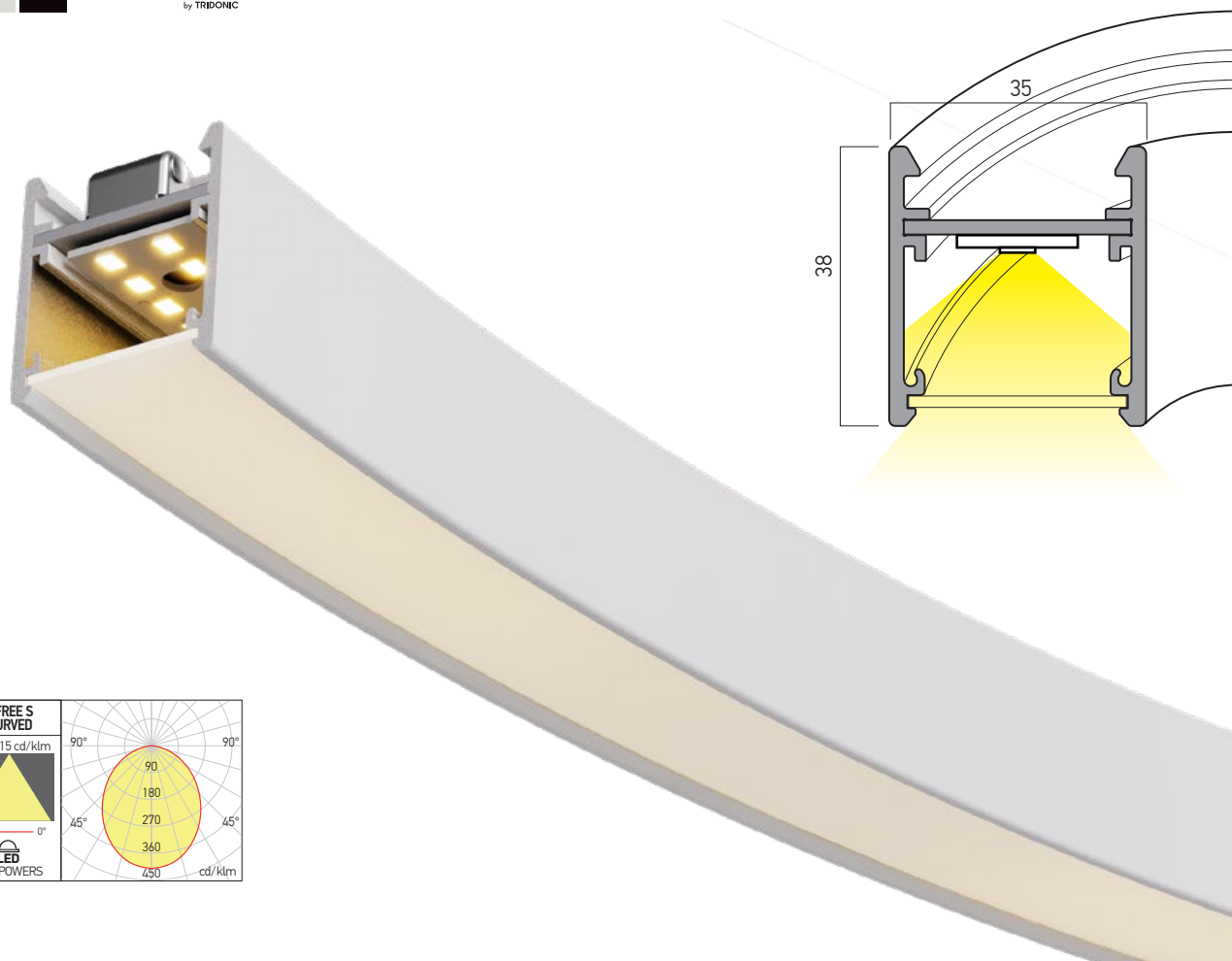

CURVED PROFILES

Light fittings with curved shape, for surface or suspended mounting, installing in continuous lines or individual mounting. Equipped with 48V DC, SMD LEDs modules.

Corpuri de iluminat cu formă rotundă pentru montaj aparent sau suspendat, instalare în structuri continue sau individual. Sunt echipate cu module cu LED-uri SMD alimentate la 48V DC.

Apparecchi archi di cerchi per installazione di superficie o come sospensione in strutture continue o singole. Dotati di moduli LED SMD alimentati a 48V DC.

CURVED RADIUS AND SECTORS DEGREE AVAILABLE

	22,5°	30°	45°	60°	90°	120°	180°
Curvature radius							
300mm	-	-	-	-	-	-	✓
500mm	-	-	-	✓	✓	✓	✓
750mm	✓	-	✓	-	✓	-	-
1000mm	-	-	-	-	✓	-	✓
1200mm	-	-	✓	-	-	-	-
1500mm	✓	-	✓	✓	✓	-	-
2000mm	-	-	✓	-	-	-	-
2400mm	-	-	✓	-	-	-	-
3000mm	-	✓	✓	-	-	-	-



xfree s

CURVED PROFILES **CASAMBI**
by TRIDONIC

FINISHING AVAILABLE

SWH **SBK**



750mm CURVATURE RADIUS

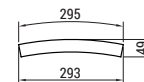

Code	Finishing	LED type	Power	Input voltage	Driver	LED flux	System flux	CCT	CRI	Optics	Weight
FES75WW22.5 SWH	SWH	LEDs MODULE	8W	48V DC	Excluded	914 lm	602 lm	3000K	90	100°	0,40 kg
FES75WW22.5 SBK	SBK	LEDs MODULE	8W	48V DC	Excluded	914 lm	602 lm	3000K	90	100°	0,40 kg
FES75NW22.5 SWH	SWH	LEDs MODULE	8W	48V DC	Excluded	942 lm	625 lm	4000K	90	100°	0,40 kg
FES75NW22.5 SBK	SBK	LEDs MODULE	8W	48V DC	Excluded	942 lm	625 lm	4000K	90	100°	0,40 kg



1500mm CURVATURE RADIUS

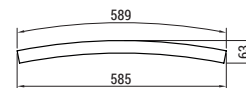

Code	Finishing	LED type	Power	Input voltage	Driver	LED flux	System flux	CCT	CRI	Optics	Weight
FES150WW22.5 SWH	SWH	LEDs MODULE	14W	48V DC	Excluded	1598 lm	1053 lm	3000K	90	100°	0,60 kg
FES150WW22.5 SBK	SBK	LEDs MODULE	14W	48V DC	Excluded	1598 lm	1053 lm	3000K	90	100°	0,60 kg
FES150NW22.5 SWH	SWH	LEDs MODULE	14W	48V DC	Excluded	1646 lm	1094 lm	4000K	90	100°	0,60 kg
FES150NW22.5 SBK	SBK	LEDs MODULE	14W	48V DC	Excluded	1646 lm	1094 lm	4000K	90	100°	0,60 kg



3000mm CURVATURE RADIUS



Code	Finishing	LED type	Power	Input voltage	Driver	LED flux	System flux	CCT	CRI	Optics	Weight
FES300WW30 SWH	SWH	LEDs MODULE	39W	48V DC	Excluded	4454 lm	2928 lm	3000K	90	100°	1,30 kg
FES300WW30 SBK	SBK	LEDs MODULE	39W	48V DC	Excluded	4454 lm	2928 lm	3000K	90	100°	1,30 kg
FES300NW30 SWH	SWH	LEDs MODULE	39W	48V DC	Excluded	4588 lm	3032 lm	4000K	90	100°	1,30 kg
FES300NW30 SBK	SBK	LEDs MODULE	39W	48V DC	Excluded	4588 lm	3032 lm	4000K	90	100°	1,30 kg



750mm CURVATURE RADIUS

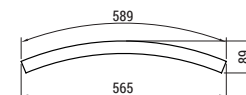

Code	Finishing	LED type	Power	Input voltage	Driver	LED flux	System flux	CCT	CRI	Optics	Weight
FES75WW45 SWH	SWH	LEDs MODULE	16W	48V DC	Excluded	1828 lm	1193 lm	3000K	90	100°	0,60 kg
FES75WW45 SBK	SBK	LEDs MODULE	16W	48V DC	Excluded	1828 lm	1193 lm	3000K	90	100°	0,60 kg
FES75NW45 SWH	SWH	LEDs MODULE	16W	48V DC	Excluded	1882 lm	1247 lm	4000K	90	100°	0,60 kg
FES75NW45 SBK	SBK	LEDs MODULE	16W	48V DC	Excluded	1882 lm	1247 lm	4000K	90	100°	0,60 kg

1200mm CURVATURE RADIUS

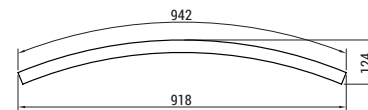

Code	Finishing	LED type	Power	Input voltage	Driver	LED flux	System flux	CCT	CRI	Optics	Weight
FES120WW45 SWH	SWH	LEDs MODULE	23W	48V DC	Excluded	2628 lm	1727 lm	3000K	90	100°	0,90 kg
FES120WW45 SBK	SBK	LEDs MODULE	23W	48V DC	Excluded	2628 lm	1727 lm	3000K	90	100°	0,90 kg
FES120NW45 SWH	SWH	LEDs MODULE	23W	48V DC	Excluded	2706 lm	1798 lm	4000K	90	100°	0,90 kg
FES120NW45 SBK	SBK	LEDs MODULE	23W	48V DC	Excluded	2706 lm	1798 lm	4000K	90	100°	0,90 kg

1500mm CURVATURE RADIUS

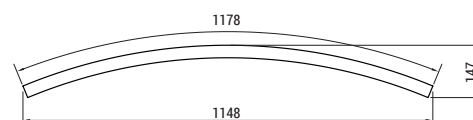

Code	Finishing	LED type	Power	Input voltage	Driver	LED flux	System flux	CCT	CRI	Optics	Weight
FES150WW45 SWH	SWH	LEDs MODULE	28W	48V DC	Excluded	3198 lm	2105 lm	3000K	90	100°	1,00 kg
FES150WW45 SBK	SBK	LEDs MODULE	28W	48V DC	Excluded	3198 lm	2105 lm	3000K	90	100°	1,00 kg
FES150NW45 SWH	SWH	LEDs MODULE	28W	48V DC	Excluded	3294 lm	2173 lm	4000K	90	100°	1,00 kg
FES150NW45 SBK	SBK	LEDs MODULE	28W	48V DC	Excluded	3294 lm	2173 lm	4000K	90	100°	1,00 kg

FINISHING AVAILABLE

SWH SBK

45°

2000mm CURVATURE RADIUS



Code	Finishing	LED type	Power	Input voltage	Driver	LED flux	System flux	CCT	CRI	Optics	Weight
FES200WW45 SWH	SWH	LEDs MODULE	35W	48V DC	Excluded	4000 lm	2629 lm	3000K	90	100°	1,30 kg
FES200WW45 SBK	SBK	LEDs MODULE	35W	48V DC	Excluded	4000 lm	2629 lm	3000K	90	100°	1,30 kg
FES200NW45 SWH	SWH	LEDs MODULE	35W	48V DC	Excluded	4120 lm	2733 lm	4000K	90	100°	1,30 kg
FES200NW45 SBK	SBK	LEDs MODULE	35W	48V DC	Excluded	4120 lm	2733 lm	4000K	90	100°	1,30 kg

2400mm CURVATURE RADIUS

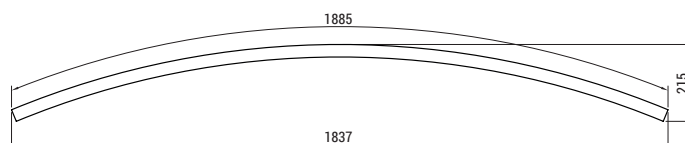

Code	Finishing	LED type	Power	Input voltage	Driver	LED flux	System flux	CCT	CRI	Optics	Weight
FES240WW45 SWH	SWH	LEDs MODULE	47W	48V DC	Excluded	5368 lm	3528 lm	3000K	90	100°	1,60 kg
FES240WW45 SBK	SBK	LEDs MODULE	47W	48V DC	Excluded	5368 lm	3528 lm	3000K	90	100°	1,60 kg
FES240NW45 SWH	SWH	LEDs MODULE	47W	48V DC	Excluded	5528 lm	3645 lm	4000K	90	100°	1,60 kg
FES240NW45 SBK	SBK	LEDs MODULE	47W	48V DC	Excluded	5528 lm	3645 lm	4000K	90	100°	1,60 kg

3000mm CURVATURE RADIUS



Code	Finishing	LED type	Power	Input voltage	Driver	LED flux	System flux	CCT	CRI	Optics	Weight
FES300WW45 SWH	SWH	LEDs MODULE	60W	48V DC	Excluded	6852 lm	4521 lm	3000K	90	100°	2,00 kg
FES300WW45 SBK	SBK	LEDs MODULE	60W	48V DC	Excluded	6852 lm	4521 lm	3000K	90	100°	2,00 kg
FES300NW45 SWH	SWH	LEDs MODULE	60W	48V DC	Excluded	7058 lm	4678 lm	4000K	90	100°	2,00 kg
FES300NW45 SBK	SBK	LEDs MODULE	60W	48V DC	Excluded	7058 lm	4678 lm	4000K	90	100°	2,00 kg

60°

500mm CURVATURE RADIUS

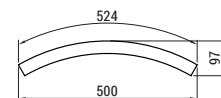

Code	Finishing	LED type	Power	Input voltage	Driver	LED flux	System flux	CCT	CRI	Optics	Weight
FES50WW60 SWH	SWH	LEDs MODULE	12W	48V DC	Excluded	1370 lm	902 lm	3000K	90	100°	0,50 kg
FES50WW60 SBK	SBK	LEDs MODULE	12W	48V DC	Excluded	1370 lm	902 lm	3000K	90	100°	0,50 kg
FES50NW60 SWH	SWH	LEDs MODULE	12W	48V DC	Excluded	1412 lm	932 lm	4000K	90	100°	0,50 kg
FES50NW60 SBK	SBK	LEDs MODULE	12W	48V DC	Excluded	1412 lm	932 lm	4000K	90	100°	0,50 kg

1500mm CURVATURE RADIUS



Code	Finishing	LED type	Power	Input voltage	Driver	LED flux	System flux	CCT	CRI	Optics	Weight
FES150WW60 SWH	SWH	LEDs MODULE	38W	48V DC	Excluded	4340 lm	2859 lm	3000K	90	100°	1,30 kg
FES150WW60 SBK	SBK	LEDs MODULE	38W	48V DC	Excluded	4340 lm	2859 lm	3000K	90	100°	1,30 kg
FES150NW60 SWH	SWH	LEDs MODULE	38W	48V DC	Excluded	4470 lm	2968 lm	4000K	90	100°	1,30 kg
FES150NW60 SBK	SBK	LEDs MODULE	38W	48V DC	Excluded	4470 lm	2968 lm	4000K	90	100°	1,30 kg



500mm CURVATURE RADIUS

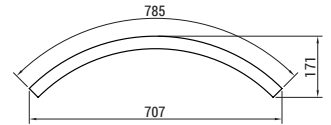

Code	Finishing	LED type	Power	Input voltage	Driver	LED flux	System flux	CCT	CRI	Optics	Weight
FES50WW90 SWH	SWH	LEDs MODULE	19W	48V DC	Excluded	2170 lm	1428 lm	3000K	90	100°	0,70 kg
FES50WW90 SBK	SBK	LEDs MODULE	19W	48V DC	Excluded	2170 lm	1428 lm	3000K	90	100°	0,70 kg
FES50NW90 SWH	SWH	LEDs MODULE	19W	48V DC	Excluded	2234 lm	1477 lm	4000K	90	100°	0,70 kg
FES50NW90 SBK	SBK	LEDs MODULE	19W	48V DC	Excluded	2234 lm	1477 lm	4000K	90	100°	0,70 kg

750mm CURVATURE RADIUS



Code	Finishing	LED type	Power	Input voltage	Driver	LED flux	System flux	CCT	CRI	Optics	Weight
FES75WW90 SWH	SWH	LEDs MODULE	31W	48V DC	Excluded	3540 lm	2327 lm	3000K	90	100°	1,00 kg
FES75WW90 SBK	SBK	LEDs MODULE	31W	48V DC	Excluded	3540 lm	2327 lm	3000K	90	100°	1,00 kg
FES75NW90 SWH	SWH	LEDs MODULE	31W	48V DC	Excluded	3646 lm	2419 lm	4000K	90	100°	1,00 kg
FES75NW90 SBK	SBK	LEDs MODULE	31W	48V DC	Excluded	3646 lm	2419 lm	4000K	90	100°	1,00 kg

1000mm CURVATURE RADIUS

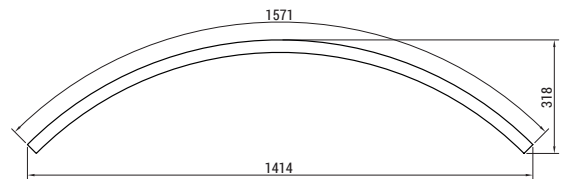

Code	Finishing	LED type	Power	Input voltage	Driver	LED flux	System flux	CCT	CRI	Optics	Weight
FES100WW90 SWH	SWH	LEDs MODULE	39W	48V DC	Excluded	4454 lm	2929 lm	3000K	90	100°	1,30 kg
FES100WW90 SBK	SBK	LEDs MODULE	39W	48V DC	Excluded	4454 lm	2929 lm	3000K	90	100°	1,30 kg
FES100NW90 SWH	SWH	LEDs MODULE	39W	48V DC	Excluded	4588 lm	3028 lm	4000K	90	100°	1,30 kg
FES100NW90 SBK	SBK	LEDs MODULE	39W	48V DC	Excluded	4588 lm	3028 lm	4000K	90	100°	1,30 kg

1500mm CURVATURE RADIUS



Code	Finishing	LED type	Power	Input voltage	Driver	LED flux	System flux	CCT	CRI	Optics	Weight
FES150WW90 SWH	SWH	LEDs MODULE	60W	48V DC	Excluded	6852 lm	4511 lm	3000K	90	100°	2,00 kg
FES150WW90 SBK	SBK	LEDs MODULE	60W	48V DC	Excluded	6852 lm	4511 lm	3000K	90	100°	2,00 kg
FES150NW90 SWH	SWH	LEDs MODULE	60W	48V DC	Excluded	7058 lm	4688 lm	4000K	90	100°	2,00 kg
FES150NW90 SBK	SBK	LEDs MODULE	60W	48V DC	Excluded	7058 lm	4688 lm	4000K	90	100°	2,00 kg



500mm CURVATURE RADIUS

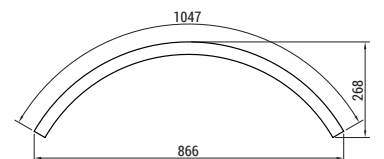

Code	Finishing	LED type	Power	Input voltage	Driver	LED flux	System flux	CCT	CRI	Optics	Weight
FES50WW120 SWH	SWH	LEDs MODULE	25W	48V DC	Excluded	2856 lm	1882 lm	3000K	90	100°	0,90 kg
FES50WW120 SBK	SBK	LEDs MODULE	25W	48V DC	Excluded	2856 lm	1882 lm	3000K	90	100°	0,90 kg
FES50NW120 SWH	SWH	LEDs MODULE	25W	48V DC	Excluded	2940 lm	1941 lm	4000K	90	100°	0,90 kg
FES50NW120 SBK	SBK	LEDs MODULE	25W	48V DC	Excluded	2940 lm	1941 lm	4000K	90	100°	0,90 kg



FINISHING AVAILABLE

SWH SBK

300mm CURVATURE RADIUS

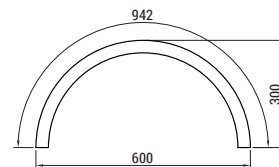

Code	Finishing	LED type	Power	Input voltage	Driver	LED flux	System flux	CCT	CRI	Optics	Weight
FES30WW180 SWH	SWH	LEDs MODULE	23W	48V DC	Excluded	2626 lm	1728 lm	3000K	90	100°	0,80 kg
FES30WW180 SBK	SBK	LEDs MODULE	23W	48V DC	Excluded	2626 lm	1728 lm	3000K	90	100°	0,80 kg
FES30NW180 SWH	SWH	LEDs MODULE	23W	48V DC	Excluded	2704 lm	1797 lm	4000K	90	100°	0,80 kg
FES30NW180 SBK	SBK	LEDs MODULE	23W	48V DC	Excluded	2704 lm	1797 lm	4000K	90	100°	0,80 kg

500mm CURVATURE RADIUS

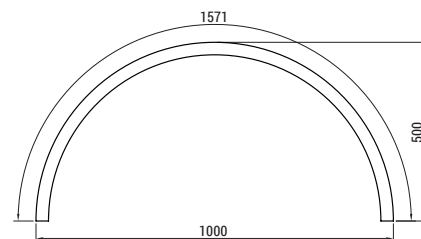

Code	Finishing	LED type	Power	Input voltage	Driver	LED flux	System flux	CCT	CRI	Optics	Weight
FES50WW180 SWH	SWH	LEDs MODULE	38W	48V DC	Excluded	4340 lm	2859 lm	3000K	90	100°	1,30 kg
FES50WW180 SBK	SBK	LEDs MODULE	38W	48V DC	Excluded	4340 lm	2859 lm	3000K	90	100°	1,30 kg
FES50NW180 SWH	SWH	LEDs MODULE	38W	48V DC	Excluded	4470 lm	2968 lm	4000K	90	100°	1,30 kg
FES50NW180 SBK	SBK	LEDs MODULE	38W	48V DC	Excluded	4470 lm	2968 lm	4000K	90	100°	1,30 kg

1000mm CURVATURE RADIUS

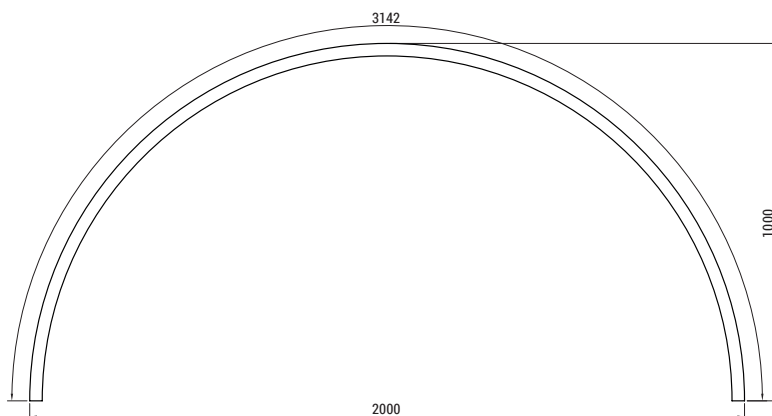

Code	Finishing	LED type	Power	Input voltage	Driver	LED flux	System flux	CCT	CRI	Optics	Weight
FES100WW180 SWH	SWH	LEDs MODULE	78W	48V DC	Excluded	8908 lm	5857 lm	3000K	90	100°	2,60 kg
FES100WW180 SBK	SBK	LEDs MODULE	78W	48V DC	Excluded	8908 lm	5857 lm	3000K	90	100°	2,60 kg
FES100NW180 SWH	SWH	LEDs MODULE	78W	48V DC	Excluded	9175 lm	6033 lm	4000K	90	100°	2,60 kg
FES100NW180 SBK	SBK	LEDs MODULE	78W	48V DC	Excluded	9175 lm	6033 lm	4000K	90	100°	2,60 kg

xfree s





xfree s

CASAMBI
by TRIDONIC

90° L CONNECTOR

FINISHING AVAILABLE

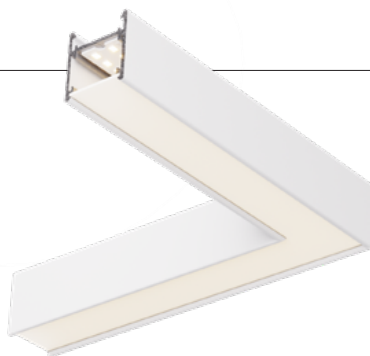
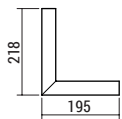
SWH
SBK

Code	Finishing	LED type	Power	Input voltage	Driver	LED flux	System flux	CCT	CRI	Optics	Weight
FES35WWLC SWH	SWH	LEDs MODULE	10W	48V DC	Excluded	1142 lm	754 lm	3000K	90	100°	0,45 kg
FES35WWLC SBK	SBK	LEDs MODULE	10W	48V DC	Excluded	1142 lm	754 lm	3000K	90	100°	0,45 kg
FES35NWLC SWH	SWH	LEDs MODULE	10W	48V DC	Excluded	1176 lm	782 lm	4000K	90	100°	0,45 kg
FES35NWLC SBK	SBK	LEDs MODULE	10W	48V DC	Excluded	1176 lm	782 lm	4000K	90	100°	0,45 kg

Structural elements, surface or suspended mounting, for connection at 90° (in L) of two light fittings from the family XFREE S.

Equipped with linear SMD LEDs modules at 48V DC.

Elemente de structură cu montaj aparent sau suspendat, pentru realizarea conexiunii la 90° (in L) între două corpuri de iluminat din gama XFREE S.

Echipat cu module liniare cu LED-uri SMD, 48V DC.

Elementi strutturali per la connessione a 90° (in L) tra due apparecchi della gamma XFREE S, montaggio di superficie o a sospensione, equipaggiato con moduli lineari a LED SMD, 48V DC.

T CONNECTOR

FINISHING AVAILABLE

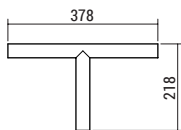
SWH
SBK

Code	Finishing	LED type	Power	Input voltage	Driver	LED flux	System flux	CCT	CRI	Optics	Weight
FES35WWTC SWH	SWH	LEDs MODULE	14W	48V DC	Excluded	1598 lm	1053 lm	3000K	90	100°	0,70 kg
FES35WWTC SBK	SBK	LEDs MODULE	14W	48V DC	Excluded	1598 lm	1053 lm	3000K	90	100°	0,70 kg
FES35NWTC SWH	SWH	LEDs MODULE	14W	48V DC	Excluded	1646 lm	1094 lm	4000K	90	100°	0,70 kg
FES35NWTC SBK	SBK	LEDs MODULE	14W	48V DC	Excluded	1646 lm	1094 lm	4000K	90	100°	0,70 kg

Structural elements, surface or suspended mounting, for connection at 90° (in T) of three light fittings from the family XFREE S.

Equipped with linear SMD LEDs modules at 48V DC.

Elemente de structură cu montaj aparent sau suspendat, pentru realizarea conexiunii la 90° (in T) între trei corpuri de iluminat din gama XFREE S.

Echipat cu module liniare cu LED-uri SMD, 48V DC.

Elementi strutturali per la connessione a 90° (in T) tra tre apparecchi della gamma XFREE S, montaggio di superficie o a sospensione, equipaggiato con moduli lineari a LED SMD, 48V DC.

CROSS CONNECTOR

FINISHING AVAILABLE

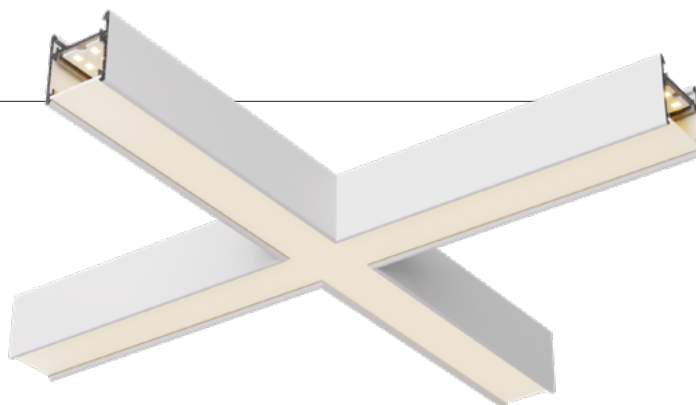
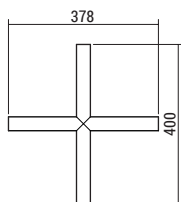
SWH
SBK

Code	Finishing	LED type	Power	Input voltage	Driver	LED flux	System flux	CCT	CRI	Optics	Weight
FES35WWXC SWH	SWH	LEDs MODULE	19W	48V DC	Excluded	2170 lm	1428 lm	3000K	90	100°	0,90 kg
FES35WWXC SBK	SBK	LEDs MODULE	19W	48V DC	Excluded	2170 lm	1428 lm	3000K	90	100°	0,90 kg
FES35NWXC SWH	SWH	LEDs MODULE	19W	48V DC	Excluded	2234 lm	1485 lm	4000K	90	100°	0,90 kg
FES35NWXC SBK	SBK	LEDs MODULE	19W	48V DC	Excluded	2234 lm	1485 lm	4000K	90	100°	0,90 kg

Structural elements, surface or suspended mounting, for connection at 90° (in X) of four light fittings from the family XFREE S.

Equipped with linear SMD LEDs modules at 48V DC.

Elemente de structură cu montaj aparent sau suspendat, pentru realizarea conexiunii la 90° (in X) între patru corpuri de iluminat din gama XFREE S.

Echipat cu module liniare cu LED-uri SMD, 48V DC.

Elemento strutturali per la connessione a 90° (in X) tra quattro apparecchi della gamma XFREE S, montaggio di superficie o a sospensione, equipaggiato con moduli lineari a LED SMD, 48V DC.



END CAPS

FINISHING AVAILABLE

SWH SBK



Code	Material	Finishing	Weight
FES35TPAL SWH	Aluminum	SWH	0,03 kg
FES35TPAL SBK	Aluminum	SBK	0,03 kg
FES35TPPC SWH	Polycarbonate	SWH	0,02 kg
FES35TPPC SBK	Polycarbonate	SBK	0,02 kg

Set of two end caps of aluminum or polycarbonate for the light fittings and luminous structures of the family XFREE S.
 Set de două elemente terminale din aluminiu sau policarbonat pentru corpurile de iluminat și structurile luminoase din familia XFREE S.
 Set composto da due testate di chiusura in alluminio o policarbonato per apparecchi e strutture luminose della famiglia XFREE S.

FIXING CLIPS



Code	Finishing
FES35SK01	Stainless steel

Set of two elastic clips in stainless steel for fixing the profiles of the XFREE S family on the ceiling.
 Set de două cleme elastice din oțel inox pentru fixarea profilelor din familia XFREE S pe tavan.
 Set di due clip elastiche in acciaio inox per il fissaggio a soffitto dei profili della famiglia XFREE S.

OPAL DIFFUSER

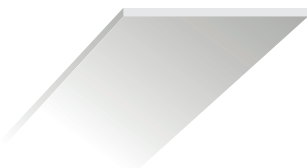

Code	Length	Weight
FES35FD300	3000 mm	0,36 kg

Satin opal polycarbonate diffuser, 3000 mm length, for direct lighting of the XFREE S system components.
 Dispersor satinat opal din policarbonat, lungimea de 3000 mm, pentru iluminatul direct la componentelor sistemului XFREE S.
 Diffusor opalino satinato in policarbonato, lunghezza 3000 mm, per l'illuminazione diretta dei componenti del sistema XFREE S.

CEILING CUP

FINISHING AVAILABLE

SWH SBK

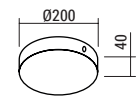

Code	Finishing	Driver	Weight
FES35PK01 SWH	SWH	for driver MEANWELL 48V 100W	0,50 kg
FES35PK01 SBK	SBK	NOT INCLUDED	0,50 kg

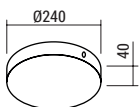

Code	Finishing	Driver	Weight
FES35PK02 SWH	SWH	for driver MEANWELL 48V 200W	0,65 kg
FES35PK02 SBK	SBK	NOT INCLUDED	0,65 kg

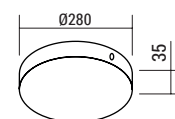

Code	Finishing	Driver	Weight
FES35PK03 SWH	SWH	for driver MEANWELL 48V 200W and CASAMBI elements	0,65 kg
FES35PK03 SBK	SBK	NOT INCLUDED	0,65 kg

Ceiling cups for electrical connections with 2P, 2x1 mm², power supply cable, 2m maximum length and 2P+N self-locking block of terminal.

The boxes are for 100W and 200W, 48V MEANWELL drivers.
 Accesorii de tavan pentru legăturile electrice, cu cablu de alimentare 2P, 2x1 mm² având lungimea maximă de 2m și șir de cleme 2P+N cu autoblocare.

Cuțiile sunt pentru alimentatoarele MEANWELL de 100W și 200W, 48V.
 Scatole con montaggio a soffitto, per gli collegamenti elettrici, cavo di alimentazione 2P, 2x1 mm², lunghezza massima da 2m e morsetteria autobloccante 2P+N.
 Le scatole sono per gli alimentatori MEANWELL da 100W e 200W, 48 V.

CONNECTION SYSTEM

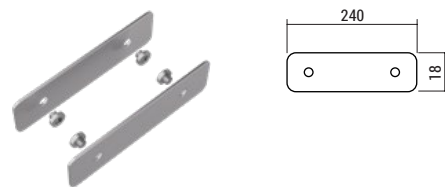

SUSPENSION KIT

FINISHING AVAILABLE

SWH SBK

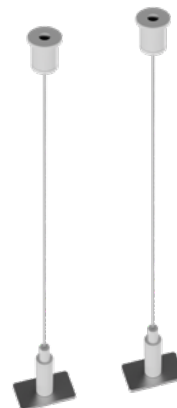

Code	Finishing	Weight
FES35SK SWH	SWH	0,05 kg
FES35SK SBK	SBK	0,05 kg

Suspension kit (two pieces) for XFREE S light fittings or structures, with a maximum length of 1,5m.
 Cable of twisted steel wires with steel fittings for fixing on the ceiling and on the light fitting.

Kit de suspendare (set de două piese) pentru corpurile sau structurile XFREE S, cu lungimea maximă de 1,5m.

Cablu torsadat din fire de oțel, cu accesorii de fixare din oțel pentru tavan și corpul de iluminat.

Kit di sospensione (due pezzi) per apparecchi singoli o per composizioni XFREE S, con lunghezza massima di 1,5m.
 Filo di acciaio intrecciato, con accessori di fissaggio in acciaio per soffitto e per apparecchio.

Code	Finishing	Weight
FES35CK	Chrome	0,03 kg

System for linear connection of two profiles or angular connectors of the XFREE S family consisting of two metal parts with four holes and recessed screws for fixing.

Sistem pentru conectarea liniară a două profile sau conectoare unghiulare din familia XFREE S, compus din doua piese metalice cu câte patru găuri și șuruburi de fixare incastrate.

Sistema di connessione per due profili lineari o connettori angolari della famiglia XFREE S, composto da due parti metalliche con quattro fori e viti incorporate per fissaggio.