

# xrope

**5 YEARS  
WARRANTY**

## EN

Lighting system with linear luminaires, linear and angular connectors in L, T and X, surface or suspended fixed systems, with the possibility to realize continuous luminous structures.

All the accessories have to be ordered separately.

The light fittings and the angular connectors are equipped with linear LED modules.

Extruded aluminum profile, electrostatically painted, with detachable central part for installing the LED modules and drivers.

Reflector and support for LEDs modules and drivers in profile of extruded aluminum.

Prismatic polycarbonate diffuser with anti-glare satin film, UGR<19 for direct lighting and satin PMMA diffuser for indirect lighting.

Constant current led drivers and WAGO type 2P+N block of terminals (10A/250V, 2,5 mm<sup>2</sup>), one at each side, to assemble the continuous linear structures.

One block of terminals 2P+N for the LED drivers.

### Range of applications

General or local lighting in offices, reception areas, conference rooms or public working spaces.

Individual mounting or in continuous light structures, with variable lengths according to the dimensions of the individual profiles.

## RO

Sistem de iluminat compus din corpuri de iluminat liniare, conectoare liniare și unghiulare în L, T și X, sisteme de fixare pentru montaj aparent sau suspendat, cu posibilitatea de realizare a structurilor luminoase continue.

Toate accesoriile se comandă separat.

Corpurile de iluminat și conectoarele unghiulare sunt echipate cu module liniare cu LED-uri.

Profil din aluminiu extrudat, vopsit în câmp electrostatic, cu partea centrală detașabilă pentru instalarea modulelor cu LED-uri și a alimentatoarelor.

Reflector și suport pentru modulele cu LED-uri și alimentatoare din profil de aluminiu extrudat.

Dispensur din policarbonat prismatic cu peliculă satinată antiiorbire, UGR<19 pentru iluminatul direct și dispersor din PMMA satinat pentru cel indirect.

Alimentatoare în curent constant și cleme de conexiuni tip WAGO 2P+N (10A/250V, 2,5 mm<sup>2</sup>), câte una la fiecare capăt, conectate între ele pentru realizarea de structuri liniare continue.

Clemă de conexiuni 2P+N pentru alimentatoarele LED.

### Aplicații

Iluminatul general sau local în birouri, zone de recepție, săli de conferințe sau spații de lucru cu publicul.

Montaj individual sau în structuri luminoase continue, cu lungimi variabile în funcție de dimensiunile profilelor individuale.

## IT

Sistema di illuminazione con apparecchi lineari, connettori lineari e angolari a L, T e X, sistemi di fissaggio a superficie o a sospensione, con possibilità di realizzare di strutture luminose continue. Tutti gli accessori devono essere ordinati separatamente.

Apparecchio e connettori angolari sono equipaggiati con moduli lineari a LED.

Profilo estruso di alluminio, verniciato a polveri, parte centrale removibile per l'installazione dei moduli LED e alimentatori.

Riflettore e supporto per moduli a LED e alimentatori in profilo estruso di alluminio.

Diffusore in policarbonato prismatico con pellicola satinata antiabbagliamento, UGR<19, per l'illuminazione diretta e in PMMA satinato per indiretta.

Alimentatori a corrente costante e morsetti tipo WAGO 2P+N (10A/250V, 2,5 mm<sup>2</sup>), uno a ciascuna estremità, collegati tra loro in modo da ottenere una struttura lineare continua.

Un blocco di morsetti 2P+N per gli alimentatori LED.

### Campi di applicazione

Illuminazione generale o locale di uffici, zone di ricezione, sale conferenza o spazi pubblici.

Installazione singola o in strutture luminose continue, a misure variabili a seconda delle dimensioni di profili individuali.



### IMPORTANT!

The light fittings from the XROPE family are standard delivered equipped with prismatic UGR<19 diffuser for direct lighting and with satin difuser for indirect lighting.

On request its can be delivered with satin diffusers for direct lighting, not with UGR<19, "black" diffusers and "blind" aluminum diffusers painted in the same color and with the same finishing as the lighting fitting.

The luminaires of the XROPE family, both those with direct lighting and those with direct/indirect lighting (for the direct part), can be equipped with dimmable DALI drivers.

In this case, the power supply cable must be 2P+N+2P (3x1 mm<sup>2</sup> + 2x0,5 mm<sup>2</sup>, control circuit).

The DALI light fittings from XROPE family can be dimmed by the following methods, using TRIDONIC/CASAMBI protocol:

- by means of TRIDONIC basicDIM Wireless Passive Module G2 wireless controller, for DALI drivers (with or without integrated DALI source).

- with the help of basicDIM Wireless G2, the DALI controller with integrated DALI source, for DALI drivers. Can be also equipped with emergency kits (excluding luminaires with length of 0,56m).

### IMPORTANT!

Corpurile de iluminat din familia XROPE se livrează echipate cu dispersor prismatic UGR<19 pentru iluminatul direct și dispersor satinat pentru iluminatul indirect.

La cerere se pot livra cu dispersoare satinat pentru iluminatul direct, fără UGR<19, dispersoare „black” și dispersoare „blind” din aluminiu vopsite în aceeași culoare și cu același finisaj ca și corpul de iluminat.

Corpurile de iluminat din familia XROPE, atât cele cu iluminat direct, cât și cele cu iluminat direct/indirect (pentru partea directă), pot fi echipate cu alimentatoare dimabile DALI.

În acest caz cablul de alimentare trebuie să fie 2P+N+2P (3x1 mm<sup>2</sup> + 2x0,5 mm<sup>2</sup>, circuitul de comandă).

Corpurile de iluminat DALI din familia XROPE pot fi reglate prin următoarele metode, folosind protocolul TRIDONIC/CASAMBI:

- utilizând regulatorul wireless basicDIM Wireless Passive Module G2, TRIDONIC, în sistem DALI, pentru alimentatoare DALI (cu sau fără sursă DALI integrată).

- cu ajutorul basicDIM Wireless G2, regulatorul DALI cu sursă DALI integrată, pentru alimentatoare DALI. Pot fi de asemenea echipate cu kit-uri de urgență (cu excepția corpurilor cu lungimea de 0,56m)



#### IMPORTANTE

Gli apparecchi di famiglia XROPE vengono equipaggiati con diffusori prismatici UGR<19 per l'illuminazione diretta e con diffusori satinati per l'illuminazione indiretta.

Su richiesta possono essere equipaggiati con diffusori satinati per l'illuminazione diretta, senza UGR<19, diffusori "neri" e diffusori "ciechi" in alluminio verniciati nello stesso colore e con la stessa finitura del corpo illuminante.

Gli apparecchi della famiglia XROPE, sia quelli a luce diretta che quelli a luce diretta/indiretta (per la parte diretta), possono essere dotati di alimentatori dimmerabili DALI. In questo caso il cavo di alimentazione deve essere 2P+N+2P (3x1 mm<sup>2</sup> + 2x0,5 mm<sup>2</sup>, circuito di controllo).

Gli apparecchi illuminanti DALI della famiglia XROPE possono essere regolati nei seguenti modi, usando il protocollo TRIDONIC/CASAMBI:

- utilizzando il controller wireless TRIDONIC basicDIM Wireless Passive Module G2, sistema DALI, per alimentatori DALI (con o senza sorgente DALI integrata).
- con l'ausilio di basicDIM Wireless G2, il controller DALI con sorgente DALI integrata, per alimentatori DALI.

Possono essere equipaggiati con kit di emergenza (senza apparecchi con lunghezza di 0,56m).

# DIRECT LIGHT PROFILES



## LINEAR PROFILES DIRECT LIGHT

FINISHING AVAILABLE

SWH SBK

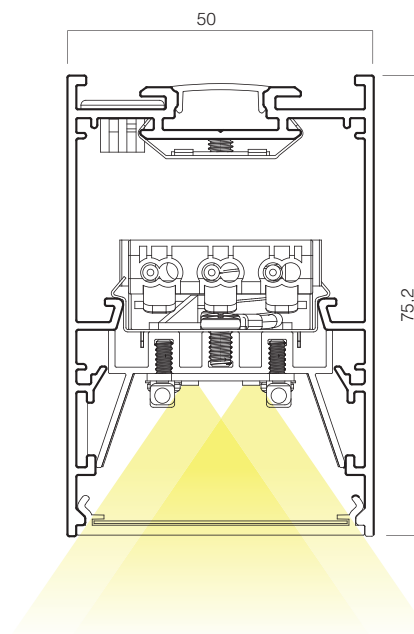
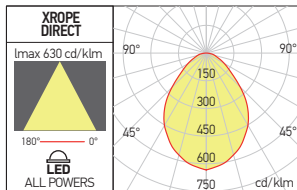

Code standard Code DALI	Finishing	LED type	Power	Input voltage	Output current/voltage driver standard/DALI	Driver	LED flux	System flux	CCT	CRI	Optics	Length (L)	Weight
RPU50WW18 SWH RPU50WW18DALI SWH	SWH	Linear LEDs module	18W	220-240V AC	Standard 500 mA / 28-42V DC DALI 500 mA / 25-42V DC	Included	2092 lm	1392 lm	3000K	90	80°	560 mm	1,15 kg
RPU50NW18 SWH RPU50NW18DALI SWH	SWH												
RPU50WW18 SBK RPU50WW18DALI SBK	SBK												
RPU50NW18 SBK RPU50NW18DALI SBK	SBK												
RPU50WW36 SWH RPU50WW36DALI SWH	SWH												
RPU50NW36 SWH RPU50NW36DALI SWH	SWH												
RPU50WW36 SBK RPU50WW36DALI SBK	SBK	Linear LEDs module	36W	220-240V AC	Standard 1100 mA / 28-42V DC DALI 1050 mA / 25-42V DC	Included	4185 lm	2754 lm	3000K	90	80°	1200 mm	2,70 kg
RPU50NW36 SWH RPU50NW36DALI SWH	SWH												
RPU50WW36 SBK RPU50WW36DALI SBK	SBK												
RPU50NW36 SBK RPU50NW36DALI SBK	SBK												
RPU50WW45 SWH RPU50WW45DALI SWH	SWH												
RPU50NW45 SWH RPU50NW45DALI SWH	SWH												
RPU50WW45 SBK RPU50WW45DALI SBK	SBK	Linear LEDs module	45W	220-240V AC	Standard 1400 mA / 28-42V DC DALI 1400 mA / 25-42V DC	Included	5240 lm	3448 lm	3000K	90	80°	1517 mm	3,25 kg
RPU50NW45 SWH RPU50NW45DALI SWH	SWH												
RPU50WW45 SBK RPU50WW45DALI SBK	SBK												
RPU50NW45 SBK RPU50NW45DALI SBK	SBK												
RPU50WW60 SWH RPU50WW60DALI SWH	SWH												
RPU50NW60 SWH RPU50NW60DALI SWH	SWH												
RPU50WW60 SBK RPU50WW60DALI SBK	SBK	Linear LEDs module	60W	220-240V AC	Standard 1800 mA / 28-42V DC DALI 1800 mA / 25-42V DC	Included	6990 lm	4599 lm	3000K	90	80°	1996 mm	4,34 kg
RPU50NW60 SWH RPU50NW60DALI SWH	SWH												
RPU50WW60 SBK RPU50WW60DALI SBK	SBK												
RPU50NW60 SBK RPU50NW60DALI SBK	SBK												

Light fittings for surface or suspended mounting, for continuous luminous lines, equipped with LEDs linear modules, with linear connection, at 90°, in T or cross mounting.

Optical system with UGR<19 for the direct lighting.

The light fittings from this range can be mounted also as individual luminaires using the appropriate accessories.

The light fixture is delivered in the version with direct light and the diffuser for indirect light installed.

On request, it can be equipped with the power supply and modules for indirect lighting.

All the mounting and connecting accessories have to be ordered separately.

Corpur de iluminat pentru montaj aparent sau suspendat, cu posibilitatea de realizare a structurilor luminoase continue, liniare, cu unghiuri de 90°, în T sau în cruce, echipate cu module liniare cu LED-uri.

Sistem optic cu UGR<19 pentru iluminatul direct.

Corpurile de iluminat din gama XROPE pot fi montate și individual utilizând accesoriile corespunzătoare.

Corpul de iluminat se livrează în variantă cu lumină directă și dispersorul pentru lumină indirectă instalat.

La cerere se pot echipa cu alimentatorul și modulele pentru iluminatul indirect.

Toate accesoriile de montaj și de conexiune se comandă separat.

Apparecchi per montaggio di superficie o a sospensione, dotati di moduli lineari a LED, permette la realizzazione di strutture luminose lineari, con angoli di 90°, connessioni a T e a croce, sistema ottico con UGR<19.

Gli apparecchi di questo sistema, possono anche essere montati singolarmente utilizzando gli accessori appropriati. L'apparecchio viene consegnato nella versione a luce diretta compreso di diffusore per luce indiretta.

Su richiesta possono essere dotati dell'alimentatore e dei moduli per l'illuminazione indiretta.

Tutti gli accessori di montaggio e di connessione devono essere ordinati separatamente.

## L 90° CONNECTOR DIRECT LIGHT

FINISHING AVAILABLE

SWH SBK

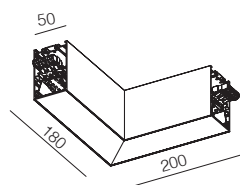

Code	Finishing	LED type	Power	Input voltage	Output current/voltage driver	Driver	LED flux	System flux	CCT	CRI	Optics	Weight
<b>RPU50WWLC9 SWH</b>	SWH	Linear LEDs module	9W	220-240V AC	300 mA / 28-42V DC	Included	1040 lm	694 lm	3000K	90	80°	0,80 kg
<b>RPU50WWLC9 SBK</b>	SBK	Linear LEDs module	9W	220-240V AC	300 mA / 28-42V DC	Included	1040 lm	694 lm	3000K	90	80°	0,80 kg
<b>RPU50NWLC9 SWH</b>	SWH	Linear LEDs module	9W	220-240V AC	300 mA / 28-42V DC	Included	1080 lm	729 lm	4000K	90	80°	0,80 kg
<b>RPU50NWLC9 SBK</b>	SBK	Linear LEDs module	9W	220-240V AC	300 mA / 28-42V DC	Included	1080 lm	729 lm	4000K	90	80°	0,80 kg

Structural elements, surface or suspended mounting, for connection at 90° of two light fittings from the family XROPE. Equipped with linear SMD LEDs modules. Optical system with UGR<19 for the direct lighting. The L connector is delivered with direct light and the diffuser for indirect light installed.

*Elemente de structură cu montaj aparent sau suspendat, pentru realizarea conexiunii la 90° între două corpuri de iluminat din gama XROPE. Echipate cu module liniare cu LED-uri SMD. Sistem optic cu UGR<19 pentru iluminatul direct. Conectorul L se livrează cu lumină directă și dispersorul pentru lumină indirectă instalat.*

Elementi strutturali per la connessione a 90° tra due apparecchi della gamma XROPE, montaggio di superficie o a sospensione. Equipaggiati con moduli lineari a LED SMD e sistema ottico con UGR<19. Il connettore viene consegnato nella versione a luce diretta compreso di diffusore per luce indiretta.

## T CONNECTOR DIRECT LIGHT

FINISHING AVAILABLE

SWH SBK

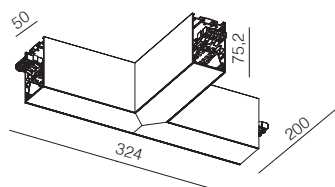
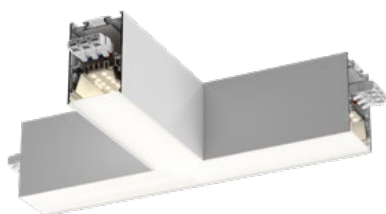

Code	Finishing	LED type	Power	Input voltage	Output current/voltage driver	Driver	LED flux	System flux	CCT	CRI	Optics	Weight
<b>RPU50WWTC14 SWH</b>	SWH	Linear LEDs module	14W	220-240V AC	450 mA / 28-42V DC	Included	1650 lm	1076 lm	3000K	90	80°	1,10 kg
<b>RPU50WWTC14 SBK</b>	SBK	Linear LEDs module	14W	220-240V AC	450 mA / 28-42V DC	Included	1650 lm	1076 lm	3000K	90	80°	1,10 kg
<b>RPU50NWTC14 SWH</b>	SWH	Linear LEDs module	14W	220-240V AC	450 mA / 28-42V DC	Included	1740 lm	1139 lm	4000K	90	80°	1,10 kg
<b>RPU50NWTC14 SBK</b>	SBK	Linear LEDs module	14W	220-240V AC	450 mA / 28-42V DC	Included	1740 lm	1139 lm	4000K	90	80°	1,10 kg

Structural elements, surface or suspended mounting, for connection of three light fittings from the family XROPE. Equipped with linear SMD LEDs modules and optical system with UGR<19 for the direct lighting. The T connector is delivered with direct light and the diffuser for indirect light installed.

*Elemente de structură cu montaj aparent sau suspendat, pentru realizarea conexiunii între trei corpuri de iluminat din gama XROPE. Echipate cu module liniare cu LED-uri SMD și sistem optic cu UGR<19 pentru iluminatul direct. Conectorul T se livrează cu lumină directă și dispersorul pentru lumină indirectă instalat.*

Elementi strutturali per la connessione tra tre apparecchi della gamma XROPE, montaggio di superficie o a sospensione. Equipaggiati con moduli lineari a LED SMD e sistema ottico con UGR<19. Il connettore viene consegnato nella versione a luce diretta compreso di diffusore per luce indiretta.

## CROSS CONNECTOR DIRECT LIGHT

FINISHING AVAILABLE

SWH SBK

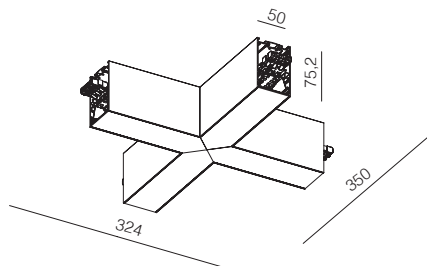
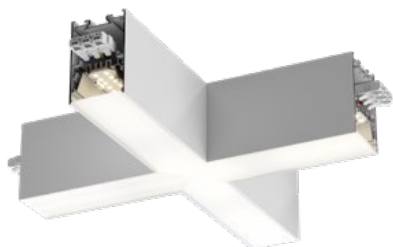

Code	Finishing	LED type	Power	Input voltage	Output current/voltage driver	Driver	LED flux	System flux	CCT	CRI	Optics	Weight
<b>RPU50WWXC18 SWH</b>	SWH	Linear LEDs module	18W	220-240V AC	600 mA / 28-42V DC	Included	2210 lm	1463 lm	3000K	90	80°	1,40 kg
<b>RPU50WWXC18 SBK</b>	SBK	Linear LEDs module	18W	220-240V AC	600 mA / 28-42V DC	Included	2210 lm	1463 lm	3000K	90	80°	1,40 kg
<b>RPU50NWXC18 SWH</b>	SWH	Linear LEDs module	18W	220-240V AC	600 mA / 28-42V DC	Included	2310 lm	1542 lm	4000K	90	80°	1,40 kg
<b>RPU50NWXC18 SBK</b>	SBK	Linear LEDs module	18W	220-240V AC	600 mA / 28-42V DC	Included	2310 lm	1542 lm	4000K	90	80°	1,40 kg

Structural elements, surface or suspended mounting, for connection of four light fittings from the family XROPE. Equipped with linear SMD LEDs modules and optical system with UGR<19 for the direct lighting. The X connector is delivered with direct light and the diffuser for indirect light installed.

*Elemente de structură cu montaj aparent sau suspendat, pentru realizarea conexiunii între patru corpuri de iluminat din gama XROPE. Echipate cu module liniare cu LED-uri SMD și sistem optic cu UGR<19 pentru iluminatul direct. Conectorul X se livrează cu lumină directă și dispersorul pentru lumină indirectă instalat.*

Elementi strutturali per la connessione tra quattro apparecchi della gamma XROPE, montaggio di superficie o a sospensione. Equipaggiati con moduli lineari a LED SMD e sistema ottico con UGR<19. Il connettore viene consegnato nella versione a luce diretta compreso di diffusore per luce indiretta.

xrope





44

xrope

# DIRECT/INDIRECT LIGHT PROFILES

## LINEAR PROFILES DIRECT/INDIRECT LIGHT



FINISHING AVAILABLE

SWH SBK



Light fittings for suspended mounting, for continuous luminous lines, equipped with LEDs linear modules, with linear connection, at 90°, in T or cross mounting.

Optical system with UGR<19 for the direct lighting.

The light fittings from this range can be mounted also as individual luminaires using the appropriate accessories.

The light fixtures are delivered with direct light and indirect light.

All the mounting and connecting accessories have to be ordered separately.

Corpuri de iluminat pentru montaj suspendat, cu posibilitatea de realizare a structurilor luminoase continue, liniare, cu unghiuri de 90°, în T sau în cruce, echipate cu module liniare.

Sistem optic cu UGR<19 pentru iluminatul direct.

Corpurile de iluminat din gama XROPE pot fi montate și individual utilizând accesoriile corespunzătoare.

Corpuri de iluminat se livrează cu lumină directă și indirectă.

Toate accesoriile de montaj și de conexiune se comandă separat.

Apparecchi per montaggio a sospensione, dotati di moduli lineari a LED, permette la realizzazione di strutture luminose lineari, con angoli di 90°, connessioni a T e a croce, sistema ottico con UGR<19.

Gli apparecchi di questo sistema, possono anche essere montati singolarmente utilizzando gli accessori appropriati.

L'apparecchi sono consegnati con luce diretta e indiretta.

Tutti gli accessori di montaggio e di connessione devono essere ordinati separatamente.

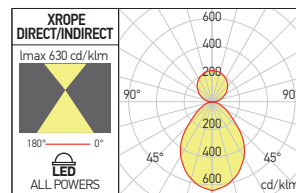
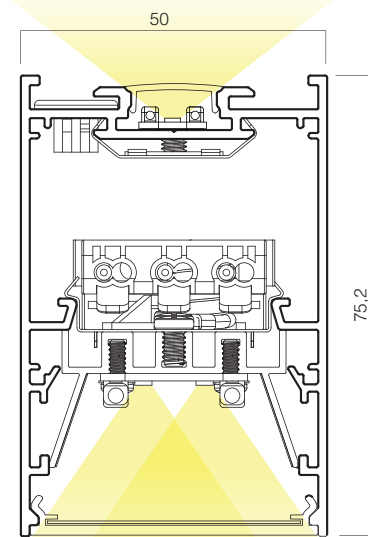

Code standard Code DALI	Finishing	LED type	Power	Input voltage	Output current/voltage driver standard/DALI	Driver	LED flux	System flux	CCT	CRI	Optics	Length (L)	Weight
RPU50WW18+6 SWH	SWH	Linear LEDs module	24W 6 up / 18 down	220-240V AC	Standard: 200 mA / 28-42V DC 500 mA / 28-42V DC DALI	Included	2792 lm	1853 lm	3000K	90	80°	560 mm	1,28 kg
RPU50WW18+6DALI SWH							700 up	461 up					
RPU50WW18+6 SBK	SBK						2092 down	1392 down					
RPU50NW18+6 SWH	SWH						2960 lm	1948 lm					
RPU50NW18+6DALI SWH							740 up	484 up					
RPU50NW18+6 SBK	SBK						2220 down	1464 down					
RPU50WW36+12 SWH	SWH	Linear LEDs module	48W 12 up / 36 down	220-240V AC	Standard 400 mA / 28-42V DC 1100 mA / 28-42V DC DALI	Included	5585 lm	3676 lm	3000K	90	80°	1200 mm	2,85 kg
RPU50WW36+12DALI SWH							1400 up	922 up					
RPU50WW36+12 SBK	SBK						4185 down	2754 down					
RPU50NW36+12 SWH	SWH						5910 lm	3912 lm					
RPU50NW36+12DALI SWH							1455 up	971 up					
RPU50NW36+12 SBK	SBK						4455 down	2931 down					
RPU50WW45+15 SWH	SWH	Linear LEDs module	60W 15 up / 45 down	220-240V AC	Standard 500 mA / 28-42V DC 1400 mA / 28-42V DC DALI	Included	6950 lm	4604 lm	3000K	90	80°	1517 mm	3,40 kg
RPU50WW45+15DALI SWH							1710 up	1156 up					
RPU50WW45+15 SBK	SBK						5240 down	3448 down					
RPU50NW45+15 SWH	SWH						7350 lm	4872 lm					
RPU50NW45+15DALI SWH							1780 up	1209 up					
RPU50NW45+15 SBK	SBK						5570 down	3663 down					
RPU50WW60+20 SWH	SWH	Linear LEDs module	80W 20 up / 60 down	220-240V AC	Standard 650 mA / 28-42V DC 1800 mA / 28-42V DC DALI	Included	9410 lm	6135 lm	3000K	90	80°	1996 mm	4,49 kg
RPU50WW60+20DALI SWH							2420 up	1536 up					
RPU50WW60+20 SBK	SBK						6990 down	4599 down					
RPU50NW60+20 SWH	SWH						9890 lm	6500 lm					
RPU50NW60+20DALI SWH							2465 up	1625 up					
RPU50NW60+20 SBK	SBK						7425 down	4875 down					

### L 90° CONNECTOR DIRECT/INDIRECT LIGHT

FINISHING AVAILABLE

SWH SBK

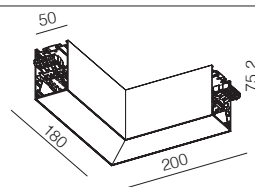

Code	Finishing	LED type	Power	Input voltage	Output current/voltage driver	Driver	LED flux	System flux	CCT	CRI	Optics	Weight
<b>RPU50WWLC9+3 SWH</b>	SWH	Linear LEDs module	12W 3 up / 9 down	220-240V AC	110 mA / 30-40V DC / 300 mA / 28-42V DC	Included	1390 lm 350 up / 1040 down	925 lm 231 up / 694 down	3000K	90	80°	0,90 kg
<b>RPU50WWLC9+3 SBK</b>	SBK	Linear LEDs module	12W 3 up / 9 down	220-240V AC	110 mA / 30-40V DC / 300 mA / 28-42V DC	Included	1390 lm 350 up / 1040 down	925 lm 231 up / 694 down	3000K	90	80°	0,90 kg
<b>RPU50NWLC9+3 SWH</b>	SWH	Linear LEDs module	12W 3 up / 9 down	220-240V AC	110 mA / 30-40V DC / 300 mA / 28-42V DC	Included	1445 lm 365 up / 1080 down	971 lm 243 up / 728 down	4000K	90	80°	0,90 kg
<b>RPU50NWLC9+3 SBK</b>	SBK	Linear LEDs module	12W 3 up / 9 down	220-240V AC	110 mA / 30-40V DC / 300 mA / 28-42V DC	Included	1445 lm 365 up / 1080 down	971 lm 243 up / 728 down	4000K	90	80°	0,90 kg

Structural elements, suspended mounting, for connection at 90° of two light fittings from the family XROPE.

Equipped with linear SMD LEDs modules and optical system with UGR<19 for the direct lighting. The L connector is equipped with modules and drivers for direct and indirect light.

*Elemente de structură cu montaj suspendat, pentru realizarea conexiunii la 90° între două corpuri de iluminat din gama XROPE. Echipate cu module liniare cu LED-uri SMD și sistem optic cu UGR<19 pentru iluminatul direct. Conectorul L este echipat cu module și alimentatoare pentru lumină directă și indirectă.*

Elementi strutturali per la connessione a 90° tra due apparecchi della gamma XROPE, montaggio a sospensione. Equipaggiati con moduli lineari a LED SMD e sistema ottico con UGR<19. Il connettore viene consegnato con moduli e alimentatori per luce diretta e indiretta.

### T CONNECTOR DIRECT/INDIRECT LIGHT

FINISHING AVAILABLE

SWH SBK

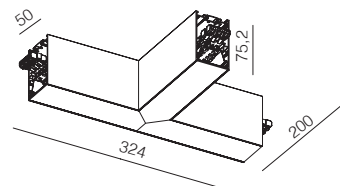
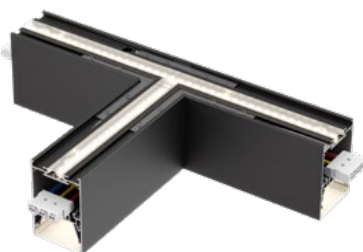

Code	Finishing	LED type	Power	Input voltage	Output current/voltage driver	Driver	LED flux	System flux	CCT	CRI	Optics	Weight
<b>RPU50WWTC14+5 SWH</b>	SWH	Linear LEDs module	19W 5 up / 14 down	220-240V AC	160 mA / 30-40V DC / 450 mA / 28-42V DC	Included	2200 lm 550 up / 1650 down	1433 lm 357 up / 1076 down	3000K	90	80°	1,20 kg
<b>RPU50WWTC14+5 SBK</b>	SBK	Linear LEDs module	19W 5 up / 14 down	220-240V AC	160 mA / 30-40V DC / 450 mA / 28-42V DC	Included	2200 lm 550 up / 1650 down	1433 lm 357 up / 1076 down	3000K	90	80°	1,20 kg
<b>RPU50NWTC14+5 SWH</b>	SWH	Linear LEDs module	19W 5 up / 14 down	220-240V AC	160 mA / 30-40V DC / 450 mA / 28-42V DC	Included	2340 lm 610 up / 1730 down	1543 lm 404 up / 1139 down	4000K	90	80°	1,20 kg
<b>RPU50NWTC14+5 SBK</b>	SBK	Linear LEDs module	19W 5 up / 14 down	220-240V AC	160 mA / 30-40V DC / 450 mA / 28-42V DC	Included	2340 lm 610 up / 1730 down	1543 lm 404 up / 1139 down	4000K	90	80°	1,20 kg

Structural elements, suspended mounting, for connection at 90° of three light fittings from the family XROPE.

Equipped with linear SMD LEDs modules and optical system with UGR<19 for the direct lighting. The T connector is equipped with modules and drivers for direct and indirect light.

*Elemente de structură cu montaj suspendat, pentru realizarea conexiunii la 90° între trei corpuri de iluminat din gama XROPE. Echipate cu module liniare cu LED-uri SMD și sistem optic cu UGR<19 pentru iluminatul direct. Conectorul T este echipat cu module și alimentatoare pentru lumină directă și indirectă.*

Elementi strutturali per la connessione a 90° tra tre apparecchi della gamma XROPE, montaggio a sospensione. Equipaggiati con moduli lineari a LED SMD e sistema ottico con UGR<19. Il connettore viene consegnato con moduli e alimentatori per luce diretta e indiretta.

### CROSS CONNECTOR DIRECT/INDIRECT LIGHT

FINISHING AVAILABLE

SWH SBK

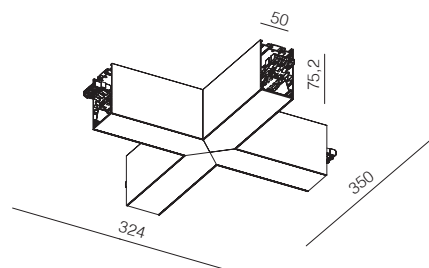
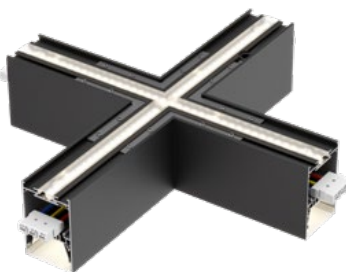

Code	Finishing	LED type	Power	Input voltage	Output current/voltage driver	Driver	LED flux	System flux	CCT	CRI	Optics	Weight
<b>RPU50WWXC18+6 SWH</b>	SWH	Linear LEDs module	24W 6 up / 18 down	220-240V AC	180 mA / 30-40V DC / 600 mA / 28-42V DC	Included	2790 lm 700 up / 2090 down	1857 lm 464 up / 1393 down	3000K	90	80°	1,50 kg
<b>RPU50WWXC18+6 SBK</b>	SBK	Linear LEDs module	24W 6 up / 18 down	220-240V AC	180 mA / 30-40V DC / 600 mA / 28-42V DC	Included	2790 lm 700 up / 2090 down	1857 lm 464 up / 1393 down	3000K	90	80°	1,50 kg
<b>RPU50NWXC18+6 SWH</b>	SWH	Linear LEDs module	24W 6 up / 18 down	220-240V AC	180 mA / 30-40V DC / 600 mA / 28-42V DC	Included	2910 lm 730 up / 2180 down	1947 lm 488 up / 1459 down	4000K	90	80°	1,50 kg
<b>RPU50NWXC18+6 SBK</b>	SBK	Linear LEDs module	24W 6 up / 18 down	220-240V AC	180 mA / 30-40V DC / 600 mA / 28-42V DC	Included	2910 lm 730 up / 2180 down	1947 lm 488 up / 1459 down	4000K	90	80°	1,50 kg

Structural elements, suspended mounting, for connection at 90° of four light fittings from the family XROPE.

Equipped with linear SMD LEDs modules and optical system with UGR<19 for the direct lighting. The X connector is equipped with modules and drivers for direct and indirect light.

*Elemente de structură cu montaj suspendat, pentru realizarea conexiunii la 90° între patru corpuri de iluminat din gama XROPE. Echipate cu module liniare cu LED-uri SMD și sistem optic cu UGR<19 pentru iluminatul direct. Conectorul X este echipat cu module și alimentatoare pentru lumină directă și indirectă.*

Elementi strutturali per la connessione a 90° tra quattro apparecchi della gamma XROPE, montaggio a sospensione. Equipaggiati con moduli lineari a LED SMD e sistema ottico con UGR<19. Il connettore viene consegnato con moduli e alimentatori per luce diretta e indiretta.



# XROPE OVERVIEW



### FINISH COLORS AVAILABLE

SWH SBK

### LIGHT EMISSION OPTIONS



DIRECT LIGHT

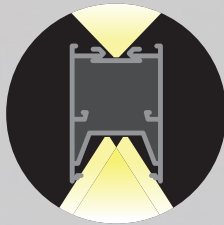

DIRECT/INDIRECT LIGHT

### INSTALLATION OPTIONS

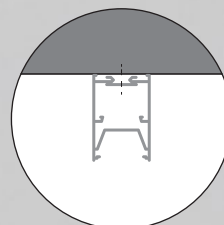

CEILING

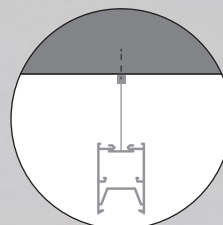

SUSPENDED

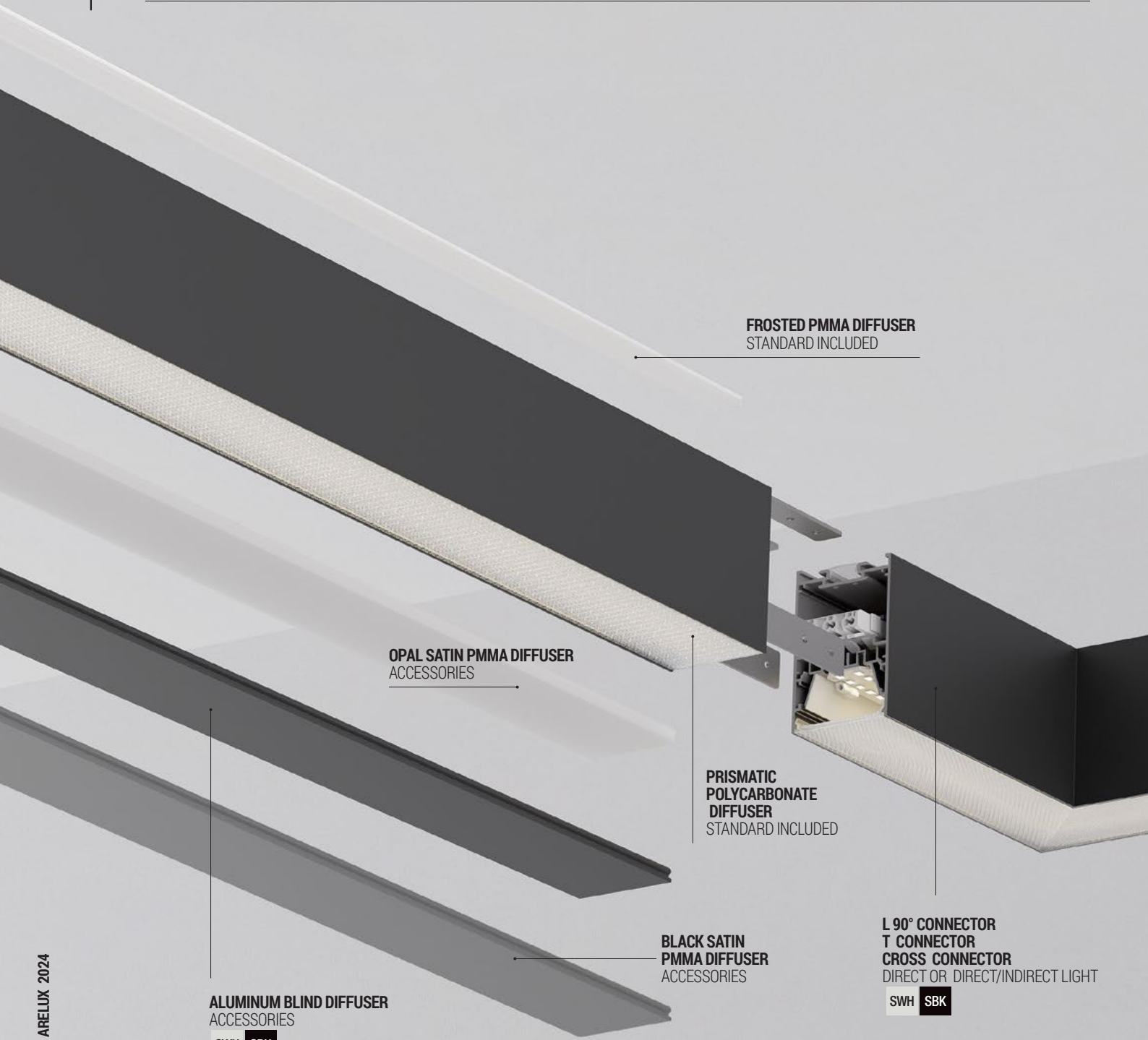

FROSTED PMMA DIFFUSER  
STANDARD INCLUDED

OPAL SATIN PMMA DIFFUSER  
ACCESSORIES

PRISMATIC  
POLYCARBONATE  
DIFFUSER  
STANDARD INCLUDED

BLACK SATIN  
PMMA DIFFUSER  
ACCESSORIES

L 90° CONNECTOR  
T CONNECTOR  
CROSS CONNECTOR  
DIRECT OR DIRECT/INDIRECT LIGHT

ALUMINUM BLIND DIFFUSER  
ACCESSORIES

SWH SBK

CEILING CUP  
ACCESSORIES

SWH SBK



SUSPENSION KIT  
ACCESSORIES

SWH SBK



CEILING CLIPS  
ACCESSORIES

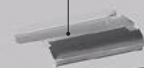

LINEAR PROFILES  
DIRECT OR DIRECT/INDIRECT LIGHT

SWH SBK



LINEAR CONNECTOR  
ACCESSORIES



**xrope****DIFFUSERS****PRISMATIC POLYCARBONATE DIFFUSER**

Code	Dimension	Weight
<b>RPU50PDD300</b>	L 3000	0,36 kg

Prismatic polycarbonate diffuser with UGR <19 satin film, 3000 mm length, for direct lighting part of the XROPE system components.

*Dispersor prismatic din policarbonat, cu film satinat UGR <19, lungimea de 3000 mm, pentru partea de iluminat direct a componentelor sistemului XROPE.*

Diffusore prismatico in policarbonato con pelicola satinata UGR <19, lunghezza 3000 mm, per l'illuminazione diretta dei componenti del sistema XROPE.

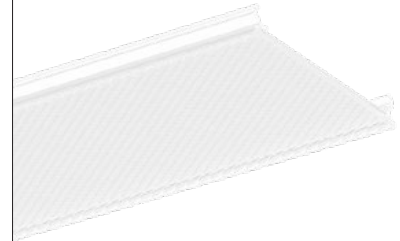
**OPAL SATIN PMMA DIFFUSER**

Code	Dimension	Weight
<b>RPU50ODD300</b>	L 3000	0,35 kg

Opal satin PMMA diffuser, 3000 mm length, for direct lighting part of the XROPE system components.

*Dispersor opal satinat din PMMA cu lungimea de 3000 mm, pentru partea de iluminat direct a componentelor sistemului XROPE.*

Diffusore opalino satinato in PMMA con lunghezza di 3000 mm, per l'illuminazione diretta dei componenti del sistema XROPE.

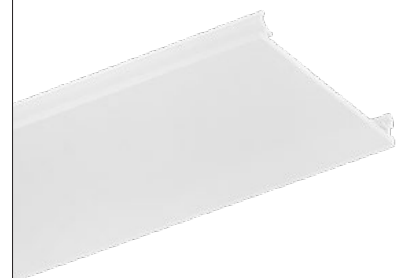
**FROSTED PMMA DIFFUSER**

Code	Dimension	Weight
<b>RPU50FDI300</b>	L 3000	0,10 kg

Frosted PMMA diffuser, 3000 mm length, for indirect lighting part of the XROPE system components.

*Dispersor satinat din PMMA cu lungimea de 3000 mm, pentru partea de iluminat indirect a componentelor sistemului XROPE.*

Diffusore satinato in PMMA con lunghezza di 3000 mm, per l'illuminazione diretta dei componenti del sistema XROPE.

**BLACK SATIN PMMA DIFFUSER**

Code	Dimension	Weight
<b>RPU50BDD300</b>	L 3000	0,30 kg

Black satin PMMA diffuser, „blind” type, 3000 mm length, for direct lighting part of the XROPE system components.

*Dispersor satinat negru din PMMA, tip „orb”, cu lungimea de 3000 mm, pentru partea de iluminat direct a componentelor sistemului XROPE.*

Diffusore nero satinato in PMMA, tipo „cieco”, con lunghezza di 3000 mm, per l'illuminazione diretta dei componenti del sistema XROPE.

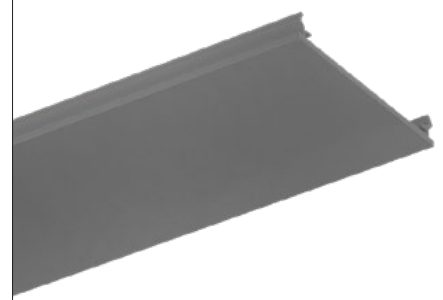
**ALUMINUM BLIND DIFFUSER**

FINISHING AVAILABLE

**SWH** **SBK**

Code	Dimension	Weight
<b>RPU50ADD200 SWH</b>	L 2000	0,30 kg
<b>RPU50ADD200 SBK</b>	L 2000	0,30 kg

Aluminum diffuser, 2000 mm length, for direct lighting part of the XROPE system components.

*Dispersor din aluminiu, lungimea de 2000 mm, pentru partea de iluminat direct a componentelor sistemului XROPE.*

Diffusore in alluminio, lunghezza 2000 mm, per l'illuminazione diretta dei componenti del sistema XROPE.

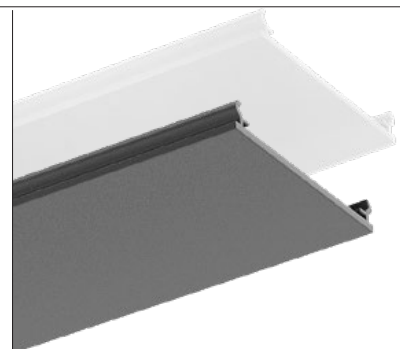

# MOUNTING ACCESSORIES

## ALUMINUM END CAPS

FINISHING AVAILABLE

SWH SBK



Code	Weight
<b>RPU50TPAL SWH</b>	0,02 kg
<b>RPU50TPAL SBK</b>	0,02 kg

Set of two end caps of aluminum, worked on CNC, for the light fittings and luminous structures of the family XROPE.

*Set de două elemente terminale din aluminiu, prelucrate CNC, pentru corpurile de iluminat și structurile luminoase din familia XROPE.*

Set composto da due testate di chiusura in alluminio lavorate a CNC, per apparecchi e strutture luminose della famiglia XROPE.

## POLYCARBONATE END CAPS

FINISHING AVAILABLE

SWH SBK



Code	Weight
<b>RPU50TPPC SWH</b>	0,01 kg
<b>RPU50TPPC SBK</b>	0,01 kg

Set of two end caps of polycarbonate for the light fittings and luminous structures of the family XROPE.

*Set de două elemente terminale din policarbonat pentru corpurile de iluminat și structurile luminoase din familia XROPE.*

Set composto da due testate di chiusura in policarbonato per apparecchi e strutture luminose della famiglia XROPE.

## CEILING CUP

FINISHING AVAILABLE

SWH SBK



Code	Dimension	Weight
<b>RPU50PK SWH</b>	90x90x60	0,13 kg
<b>RPU50PK SBK</b>	90x90x60	0,13 kg

Ceiling cup for electrical connections, with 2P+N, 3x1 mm<sup>2</sup>, power supply cable, 2m maximum length and 2P+N self-locking block of terminal.

*Accesoriu de tavan pentru legăturile electrice, cu cablu de alimentare 2P+N, 3x1 mm<sup>2</sup> având lungimea maximă de 2m și șir de cleme 2P+N cu autoblocare.*

Basetta con montaggio a soffitto, per gli collegamenti elettrici, cavo di alimentazione 2P+N, 3x1 mm<sup>2</sup>, lunghezza massima da 2m e morsettiera autobloccante 2P+N.

## SUSPENSION KIT

FINISHING AVAILABLE

SWH SBK



Code	Weight
<b>RPU50SK SWH</b>	0,05 kg
<b>RPU50SK SBK</b>	0,05 kg

Suspension kit (two pieces) for XROPE light fittings or structures, with a maximum length of 2m.

Cable of twisted steel wires with steel fittings for fixing on the ceiling and on the light fitting.

*Kit de suspendare (set de două piese) pentru corpurile sau structurile XROPE, cu lungimea maximă de 2m.*

*Cablu torsadat din fire de oțel, cu accesorii de fixare din oțel pentru tavan și corpul de iluminat.*

Kit di sospensione (due pezzi) per apparecchi singoli o per composizioni XROPE, con lunghezza massima di 2m.

Filo di acciaio intrecciato, con accessori di fissaggio in acciaio per soffitto e per apparecchio.

## CEILING CLIPS

FINISHING AVAILABLE

SS

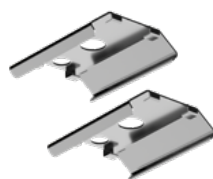

Code	Weight
<b>RPU50SK01</b>	0,005 kg

Set of two elastic clips in stainless steel for fixing the profiles of the XROPE family on the ceiling.

*Set de două cleme elastice din oțel inox pentru fixarea profilelor din familia XROPE pe tavan.*

Set di due clip elastiche in acciaio inox per il fissaggio a soffitto dei profili della famiglia XROPE.

## LINEAR CONNECTOR

FINISHING AVAILABLE

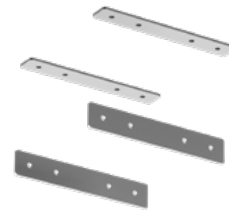

Code	Dimension	Weight
<b>RPU50CK</b>		0,06 kg

System for linear connection of two profiles or angular connectors of the XROPE family, consisting of four metal parts with 4 holes and recessed screws for fixing.

*Sistem pentru conectarea liniară a două profile sau conectoare unghiulare din familia XROPE, compus din patru piese metalice cu câte patru găuri și șuruburi de fixare încastrate.*

Sistema di connessione per due profili lineari o connettori angolari della famiglia XROPE, composto di quattro parti metalliche con 4 fori e viti incorporate per fissaggio.